

The Fold 06 LED for magnetic track lighting offers a sleek and adaptable solution for illuminating various spaces with precision and style. Its compatibility with magnetic tracks provides effortless installation and reconfiguration, allowing for dynamic lighting layouts that can evolve with changing needs. With its slender profile and customizable lengths, the linear LED seamlessly integrates into architectural designs, enhancing aesthetics while providing efficient illumination.

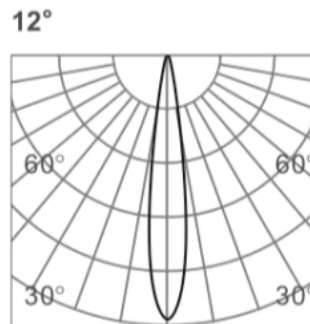

Model #	VL-FOLD06-BK
Power	8W
CCT	3000K
Mounting	Magnetic Track
Lumen Output	500
Beam Angle	12 Spot
Input Voltage	24V DC
Dimmable	Yes
CRI	90
Driver	Remote
Standard	ETL
Rated	Damp

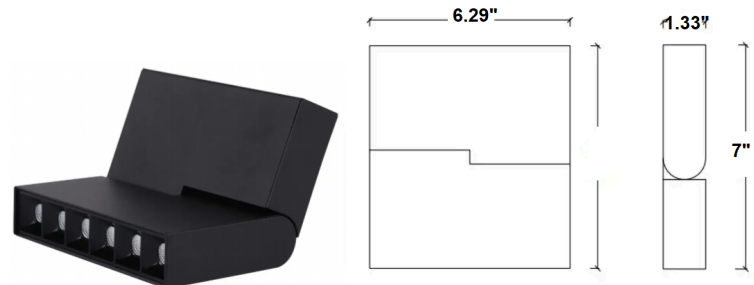

h(m)	E(lx)	Φ(m)
1	3693	Φ0.23
2	923	Φ0.47
3	410	Φ0.71
4	230	Φ0.94
5	147	Φ1.18

